

Diode-Diode MODULE HDD25NXX

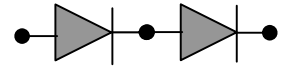

Symbol	Characteristics	Conditions	T _J (°C)	Value	Unit
BLOCKING PARAMETERS					
V _{RRM}	Repetitive peak reverse voltage		150	200-1800	V
V _{DRM}	Repetitive peak off-stage voltage		150	200-1800	V
I _{RRM}	Repetitive peak reverse current	V = V _{RRM}	150	3	mA
CONDUCTING PARAMETERS					
I _{F(AV)}	Average on-state current	180 sine, 50Hz, T _C = 100°C		25	A
I _{RMS}	RMS on-state current			40	A
I _{FSM}	Surge on-state current	Sine wave, 10mS without reverse voltage	150	500	A
I ² t	I ² t			1250	A ² S
V _T	Peak on-state voltage drop	On-state current = 80A	150	1.40	V
V ₀	Threshold voltage		25	0.85	V
R ₀	On-state slope resistance		25	6.00	mΩ
THERMAL & MECHANICAL PARAMETERS					
R _{TH(J-C)}	Thermal impedance, 180 conduction, Sine	J to C Per Arm Per Module		1.00 0.50	°C/W
R _{TH(C-HK)}	Thermal impedance	C to HK Per Arm Per Module		0.20 0.10	°C/W
T _J	Maximum Permissible junction temperature			150	°C
T _{STG}	Storage temperature range			-40 - 150	°C
V _{ISOL}	Insulation test voltage, RMS	F = 50Hz, 1 min		2.5	kV
M1	Mounting Torque			4	NM
M2	Terminal connection Torque			4	NM
W	Weight			90	gms



Diode-Diode MODULE HDD25NXX

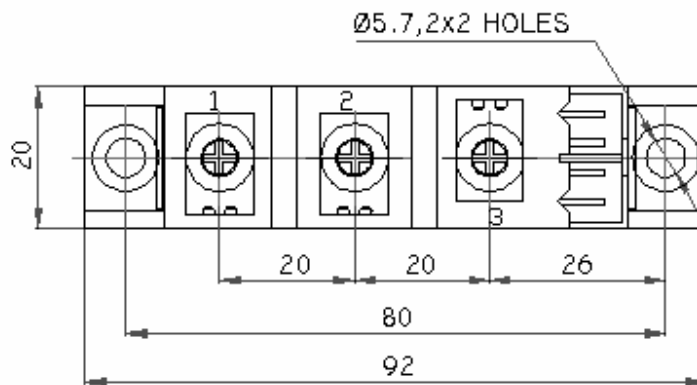
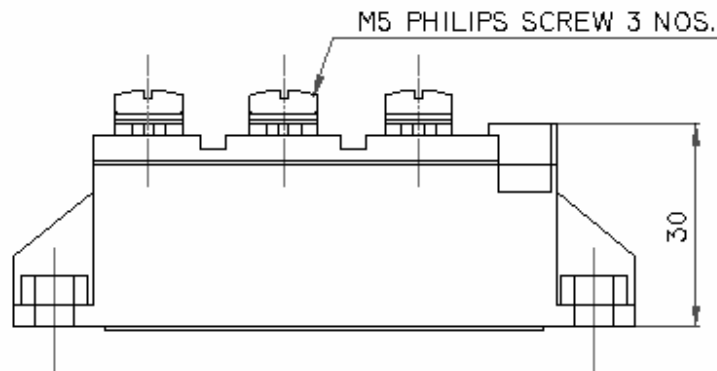
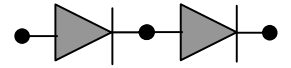

ALL DIMENSIONS IN MM

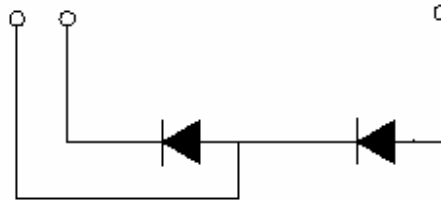

HDDXXNXX

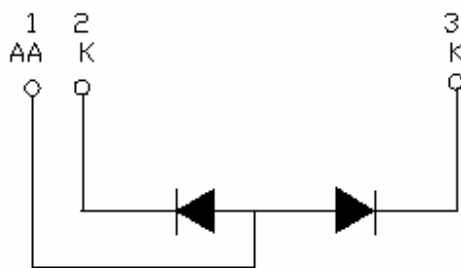

HDDXXNXX-AA

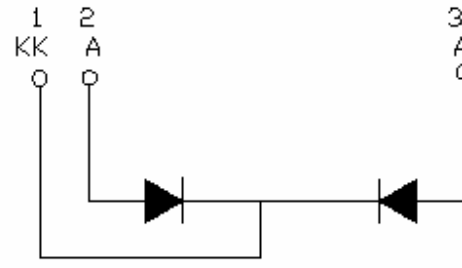

HDDXXNXX-KK



HIND RECTIFIERS LTD

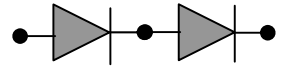

On State Power Loss

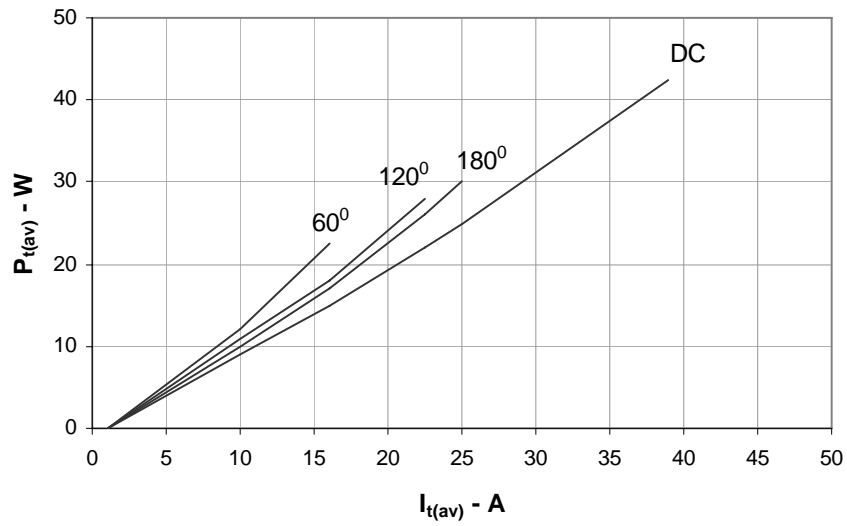

Maximum Permissible Case Temp

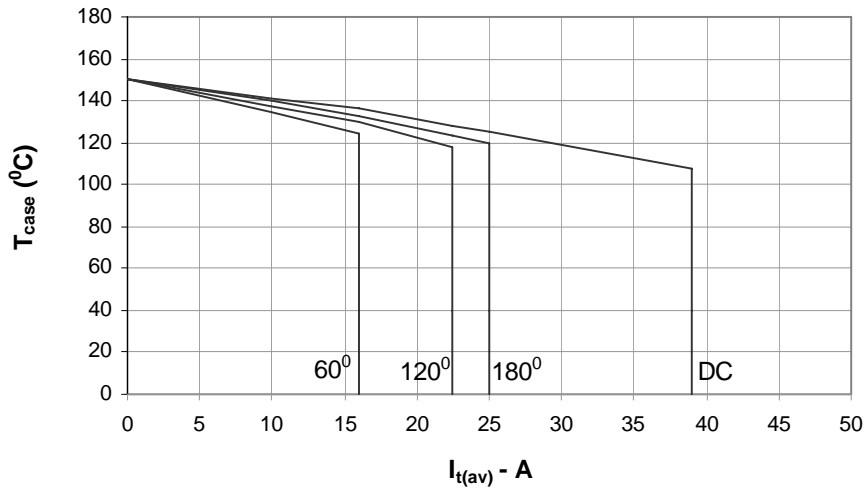

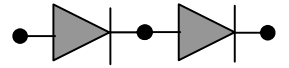

Max non repetitive Surge Current

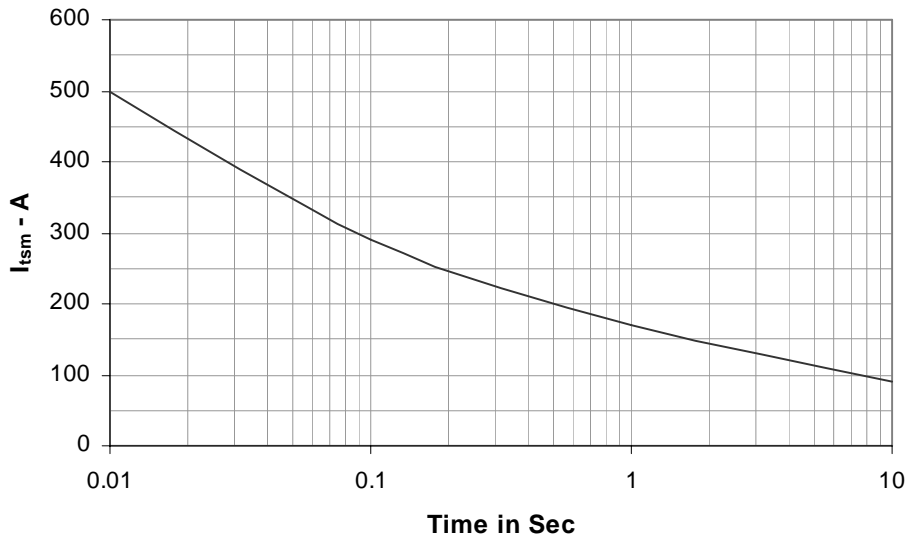

Transient Thermal Impedance Junction to Case

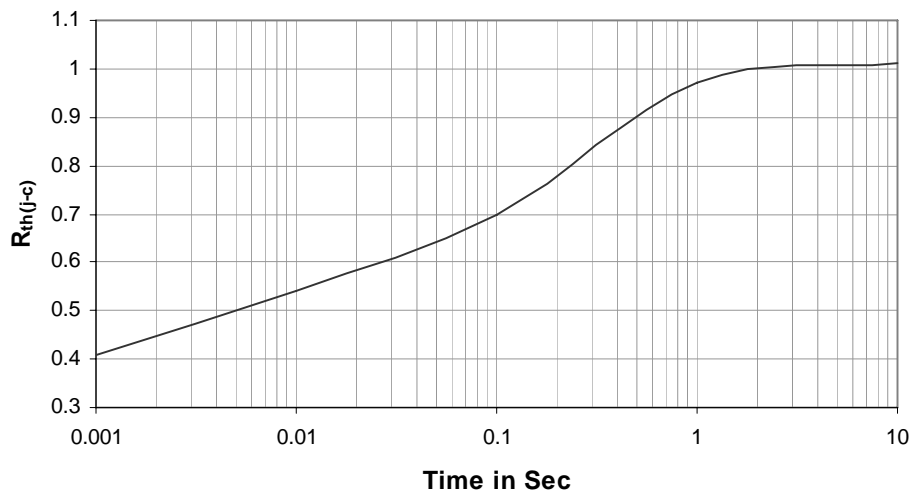

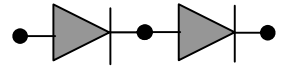

On State Characteristics

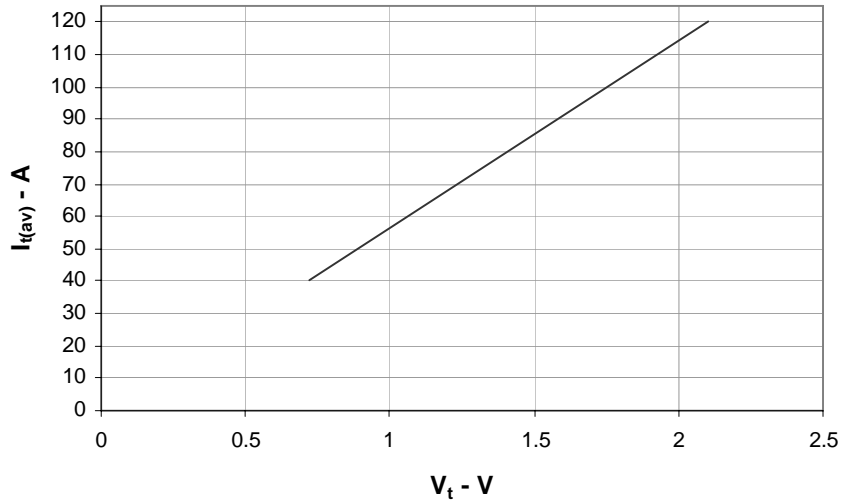

Diode-Diode MODULE HDD25NXX

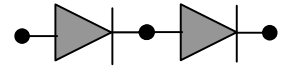

Ordering Information: -

HDD	25	N	XX
Hirect make Diode-Diode Module	$I_{F(AV)} = 25A$	Normal Thyristor	$V_{RRM} = XX * 100$ e.g. 12 * 100 = 1200V

Hind Rectifiers Ltd reserves the right to change the specifications without notice.

This datasheet specifies technical information for semiconductor devices but promises no characteristics. No warranty or guarantee expressed or implied is made regarding delivery, performance or suitability.

Hind Rectifiers Ltd
Lake Road
Bhandup (West)
Mumbai – 400 078
Tel: - +91 22 2596 8027/28/29/31
Fax: - +91 22 2596 4114
E-mail: - marketing@hirect.com
Website: - www.hirect.com

June-2008



HIND RECTIFIERS LTD

6 of 6